

APPROVED BY



ŠOSEJAS
KOMISIJA

LAF Racing Commission

Jānis Ducmanis



LITHUANIAN
AUTOMOBILE
SPORT
FEDERATION

LASF Racing Commission

Inga Kacinskiene



EAL Racing Commission

Raimo Kulli



2022 BMW 325 BALTIC CUP TECHNICAL REGULATIONS

1. GENERAL

- 1.1. These technical regulations shall come into force from 20th of March 2022 and shall remain valid until the official publication of the amendment.
- 1.2. The requirements of the FIA International Sport Code Appendix J are only applicable if there is an explicit reference to a particular article / item.
- 1.3. Car parts and their attachment must be such that they do not endanger the driver, car service personnel, third parties or third party property.
- 1.4. Everything that is not allowed in these technical regulations is forbidden. Allowed changes / redundancies should not cause or have invalid changes.
- 1.5. In the event of disagreement on the perception or application of certain points, the right to comment and clarify these technical requirements is the responsibility of the LASF Technical Requirements Committee.

2. DEFINITIONS

- 2.1. **Bodyshell** - the unit of metal body parts marked with a vehicle identification number (VIN), connected by welding or other fastening elements (glue, rivets), including the floor with the transmission tunnel and side sills, front and rear longitudinal beams (incl shock towers) and cross members between them (if they are not screwed in the production process), A, B, C pillars, roof panel with transverse beams, rear wings (if they are not screwed in during the production process), firewall between the cockpit and engine compartment, firewall (if provided) between the cockpit and luggage compartment, cross members and suspension mounting points (if they are not screwed in during the production process).
- 2.2. **Cockpit** - the space provided by the manufacturer for the driver and passengers, separated by the engine compartment firewall and it may be separated by luggage compartment firewall (including a shelf under the rear window). If any part in the cockpit space is separated by a fluid-tight and fire-proof container or bulkhead, this part is considered to be outside the cockpit.
- 2.3. **Original part** - part used in a serial production of the car model (BMW E90, E91, E92 – 325), or another part identical in shape, in operation and performance (analogue) by a different manufacturer (*example: in a BMW E90 instead of the original BMW wishbone, SWAG, FEBI, TRW, and LEMFORDER wishbones can be used*). This part can not be modified (*grinding, mashing, reshaping, etc*) in any manner.
- 2.4. **Serial part** - part used in a serial production of the car make, or another part identical in shape and in operation (analogue) by a different manufacturer (*example: in a BMW E90 car instead of the original BMW E90 LSD, BMW E36 LSD can be used*). This part can not be modified (*grinding, mashing, reshaping, etc*) in any manner.
- 2.5. **Free part** - a part that can be modified, reshaped or altered in any way or replaced by another part. Restrictions are not applied to the material or the form of the part. The part can be even removed.

3. AUTHORIZED CARS

- 3.1. BMW E90, E91 or E92 series production cars, marked with factory VIN number, starting with three letters - WBA... .
- 3.2. Technical passport of the sporting vehicle issued by the FIA or ASN is compulsory.

4. PROHIBITED CARS

- 4.1. BMW M3 (E90 or E92) series production cars, marked with factory VIN number, starting with three letters - WBS... .

- 4.2. Cars that do not meet these technical regulations.
- 4.3. Vehicles whose construction or equipment contain deficiencies which could endanger the crew, service personnel, third parties or third party property (as decided by the Competition Technical Commission).

5. CLASSES (not in use)

6. MINIMUM RACING WEIGHT

- 6.1. Minimum racing weight of a car at any time of the race (including qualifying) – 1400 kg.
- 6.2. Weighting procedure. Minimum weight is the weight of the car with the driver and driver's equipment.
- 6.3. Prior to the weighing, it is forbidden to add any objects or any liquids (including fuel) to the car.
- 6.4. Before the event it is permitted to complete weight of the car by ballast, provided that they are strong and unitary blocks, fixed by means of tools with the possibility to fix seals, placed on the floor of the cockpit.
- 6.5. **Ballast (manufacturer: Valentin Jakovlev +37062037658, v.jakovlev7@gmail.com).**

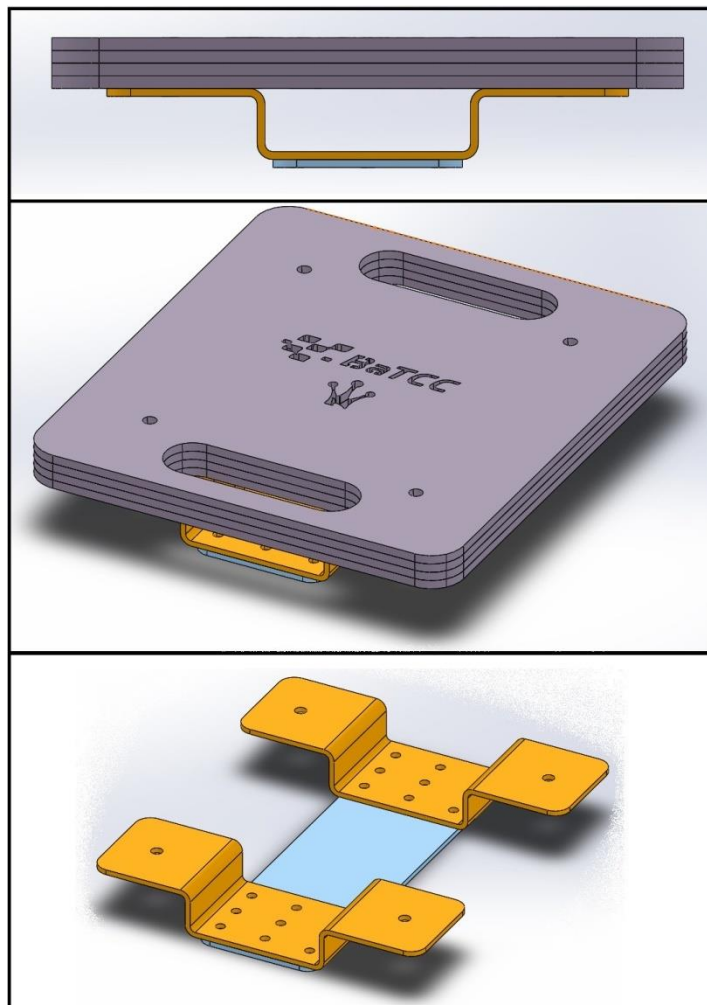

- 6.6. A weighting error of $\pm 0,25\%$ is applied.

- 6.7.** Handicap weight. Handicap weight is an additional weight for the car. If driver has finished in TOP3, for the next round an extra weight will be added according to paragraph 6.8. The maximum handicap weight is 100 kg. Handicap weight plates and fitting kit will be supplied by the promoter. Location – in place of the front passenger seat. Fitting – four M10 (length - 12 mm) studs with nuts.

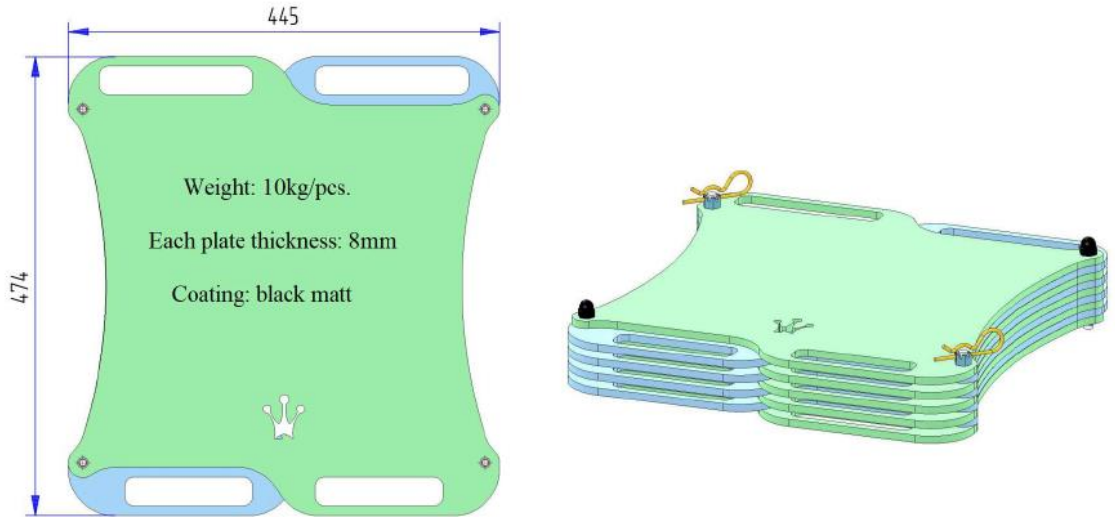

- 6.8.** Driver's place in the overall results of the event: points from RACE 1 + points from RACE 2.
Handicap weight for the next event:
- 1 place +50 kg;
 - 2 place +40 kg;
 - 3 place +30 kg;
 - 4 place 0 kg;
 - 5 place -10 kg;
 - 6 place -20 kg;
 - 7 place -30 kg;
 - 8 place -40 kg;
 - 9 place and lower -50 kg;
 - DNF -50 kg;
 - DNS 0 kg;
 - DSQ 0 kg.

7. BODYWORK

7.1. Bodyshell.

- 7.1.1. The exterior of the bodywork of the base model should be maintained and recognizable.
- 7.1.2. Bodyshell must be original but may be modified in accordance with the requirements in this paragraph. BMW (E90, E91, E92) 325 ix (X DRIVE) bodyshell may be used.
- 7.1.3. Parts, brackets (rear seat and safety belt mountings, audio speaker, wiring harnesses and electrical equipment brackets, central console mountings) whose function is not associated with the stiffening of the bodyshell and which do not engage parts of bodyshell, can be removed.
It is allowed to cut out the part of the rear seat bottom surface for an installation purpose of the FIA FT fuel tank (point 8.18.13. of these regulations). It is allowed to cut corners of the cross member, welded on the front edge of the rear seat bottom surface, for an installation purpose of the main roll bar.
- 7.1.4. Firewall and the floor – original. Driver seat cross members may be removed, for an installation purpose of racing seat cross members according to FIA J art 253-65B. Passenger seat cross members must remain original.
- 7.1.5. Spare wheel housing - original.
- 7.1.6. Roof panel - original. Roof transverse member can be removed. In the case of a sunroof, the opening must be covered (welded, riveted, glued) with the same material (same material thickness) as the original or with a 2,0 mm thickness aluminum sheet or composite panel. It is allowed (recommended) to cut-off or grind-off the inner edges of the sunroof opening to reduce the possibility of the injury.
- 7.1.7. Rear wings. It is allowed to fold back the edges of the wings on condition, that the outer shape remains unchanged.
- 7.1.8. Ventilation openings, diffusers on the roof panel - forbidden.
- 7.1.9. Reinforcement of the bodyshell is permitted.
- 7.1.10. Seam welding of the bodyshell is permitted.
- 7.1.11. Strut bars. Front – original (bars connecting shock towers with firewall). Rear – FREE (may be a part of the roll cage).
- 7.1.12. Additional hinges, threads, and fitting are permitted.

7.2. Doors, engine bonnet and boot lid, bumpers, front fenders, grills.

- 7.2.1. Front doors – original (excluding rubber moldings).
- 7.2.2. Crash box – recommended. May be made of non-combustible composite materials (minimum panel composition must comply with FIA J art 255 - 14) or made of the foam (see FIA Technical list No. 58). The panel may cover the plane from the bottom of the door to the upper edge of the roll cage side bars.
- 7.2.3. Front door window lifters – original (in working order).
- 7.2.4. The inner panel of the front doors - original (can be modified) or can be made of:
 - A sheet of metal (min thickness 0,5 mm);
 - A sheet of carbon fiber (min thickness 1,0 mm);
 - Other non-combustible materials (min thickness 2,0 mm).
- 7.2.5. Rear doors – original (excluding rubber moldings).
- 7.2.6. Rear door window lifters - original (in working order).
- 7.2.7. Inner panel of the rear doors - according to point 7.2.4. of these regulations.
- 7.2.8. All doors must be openable from both inside and outside of the car.
- 7.2.9. Engine bonnet and boot lid (including hydraulic lifters) – original (including facelift bonnet and boot lid). Heat insulation may be removed.
- 7.2.10. Original engine bonnet and boot lid locks - must be rendered inoperative or removed.
- 7.2.11. Safety pins (springs) - mandatory at least two for each engine bonnet and boot lid.
- 7.2.12. Front and rear bumpers – original (including facelift bumpers).
- 7.2.13. Front and rear bumper cross-beams - original.

- 7.2.14. Front fenders - original.
- 7.2.15. Front grilles (upper and lower) – original (including facelift grilles).
- 7.2.16. Rocker panels – original (no extra parts allowed).
- 7.2.17. Other external parts - FREE.
- 7.3. Windows, wipers, washers.**
- 7.3.1. Windscreen - original. It may be fitted with one or several transparent and colourless films on its outer surface.
- 7.3.2. It is allowed to use sun strip on the upper edge of the windscreen, on condition that it does not prevent the driver from seeing the signals and signs of the judges.
- 7.3.3. Windscreen wipers - original.
- 7.3.4. Windscreen washer system - FREE.
- 7.3.5. Side windows - original (covered with a colorless protective film in accordance with FIA J art 253 - 11).
- 7.3.6. The rear window - original.
- 7.3.7. Window vents. Airvents can be installed in the spaces between the upper edge of the rear door frame and the window.
- 7.3.8. Tinting of the windows (including the silver film) is prohibited.
- 7.3.9. Due to ventilation its allowed to open the front windows by 1/5 of the opening during the race.
- 7.4. Rear-view mirrors.**
- 7.4.1. Side view mirrors – original (including facelift mirrors).
- 7.4.2. An inside rear-view mirror - compulsory.
- 7.5. Aerodynamic elements and underguards.**
- 7.5.1. Aerodynamic elements – original.
- 7.5.2. Underguards and splash guards – original or may be removed.
- 7.6. Interior.**
- 7.6.1. Main condition - the cockpit of the car can not have open cavities with sharp, protruding edges that could injure the driver during an accident.
- 7.6.2. If any of the following - fuel tank, fuel catch tank, liquid-filled battery, fuel pumps, liquid (oil) tanks (except for water and window washer tank) – are installed in the cockpit (including open luggage compartment), they must be separated from the driver by a non-flammable, fluid-tight firewall or container.
- 7.6.3. Instrument panel (including dash, ignition port – button, climate control, glove compartment) – original. May be modified in places around the tubes of the roll cage.
- 7.6.4. Underpanel cross bar – original but may be modified.
- 7.6.5. Supplementary instruments (gauges, meters, sensors) – FREE if they do not enhance engine performance. However, it is prohibited to install mechanical instruments for engine lubrication and cooling system according to paragraph 16 of these regulations.
- 7.6.6. Horn - FREE.
- 7.6.7. Onboard cameras and radio – allowed, but must be securely fixed either on the roll cage, or on the part of bodyshell.
- 7.6.8. Other interior parts - FREE.
- 7.7. Towing eyes.**
- 7.7.1. Towing eyes (min inner diameter – 60 mm) - must be fitted in the front and in the rear. Towing eyes made from soft (belt, etc) materials are strongly recommended.
- 7.7.2. Towing eyes must be clearly visible (colored yellow, red or orange) or (and) clearly marked.
- 7.8. Air jacks.** Air jacks or similar car lifting systems are prohibited.
- 7.9. Ride height.** Not less than – 110 mm (measuring will be performed in a plane of wheelbase).

8. ENGINE

- 8.1. Original N52B25 engine allowed only.
- 8.2. Cylinder block (including oil pan) - original.
- 8.3. Cylinder diameter and piston stroke – original (82 × 78,8 mm). Due to repairs - resleeving is allowed.
- 8.4. Crankshaft – original (mashing of the bearing necks allowed).
- 8.5. Conrods and pistons (including rings and pins) - original.
- 8.6. Crankshaft main and conrod bearing shells – original (including repair shells).
- 8.7. Flywheel and pulleys - original.
- 8.8. Cylinder head (including top cover) – original. Bottom surface mashing is allowed with a condition to maintain original compression ratio according to point 8.9 of these regulations.
- 8.9. Compression ratio – original (11:1).
- 8.10. Valves and springs - original.
- 8.11. Valve drive (rocker arms, tappets) - original.
- 8.12. Camshaft (-s) – original.
- 8.13. Camshaft sprocket gear (-s), pulleys, variable timing adjusters - original.
- 8.14. Camshaft drive (chains, belts, tensioners, sliders) - original.
- 8.15. Valvetronic (including motor, shaft, etc) – original.
- 8.16. Cylinder head gasket and screws - original.
- 8.17. Engine mounting (brackets and bushings) – FREE, but original position of the engine must be retained.
- 8.18. Lubrication system - original. Installation of the oil radiator is authorized. For a purpose of that it is allowed to remove or to change original heat exchanger to oil cooler pickup housing from BMW M3 engine or other similar housing (plate).
- 8.19. Cooling system - original (including interior heating). Hoses are FREE. Thermostat may be removed.
- 8.20. Engine fuel - air supply system.
 - 8.20.1. Composition of the mixture – atmospheric air + fuel delivered from one tank of the car. Water as an additive may not be used (water injection).
 - 8.20.2. Air inlet can not be placed in the cockpit.
 - 8.20.3. Air filter box (with diffusers) - original.
 - 8.20.4. Air filter – **original**.
 - 8.20.5. Air intake lines (pipes, hoses) – original.
 - 8.20.6. Air flow meter – original.
 - 8.20.7. Throttle body (TB) – original.
 - 8.20.8. Intake manifold - original.
 - 8.20.9. Turbocharger (supercharger) – prohibited.
 - 8.20.10. Injectors - original.
 - 8.20.11. Fuel circuit, filters and catch tank - FREE. Installation according paragraph 16. Use of automatic cut-off valve on the fuel circuit is recommended. Installation according to FIA J 253 - 3.3.
 - 8.20.12. Fuel pump (-s) - FREE. Fuel pump(-s) must operate when the engine is running, except during the starting process. **Fuel pressure in the fuel injector rail – TBA.**
 - 8.20.13. Fuel tank (-s) - original or (and) FIA homologated fuel tank FT3 1999, FT3.5 or FT5 (an extension of the homologation for 2 years, without approval of the manufacturer, is allowed). Installation according to FIA J art 252 - 9.6 and FIA J art 253 - 14.

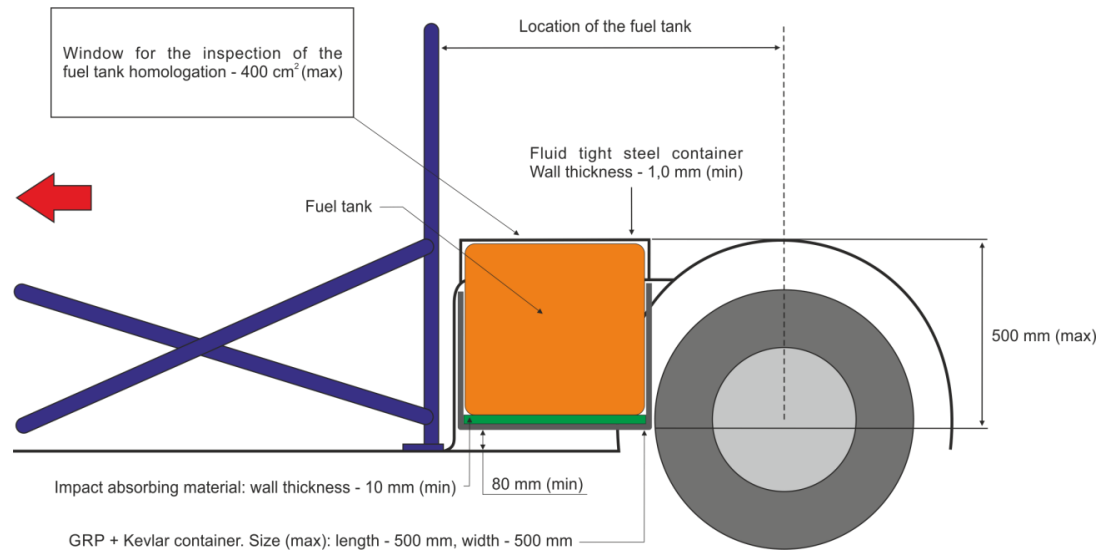

- 8.20.14. Fuel tank ventilation system and roll-over valves - original. If the original ventilation system is dismantled, the new system and parts must comply with FIA J art 253 - 3.4.
- 8.20.15. The fuel filler neck or (and) homologated fuel filler connectors must not extend beyond the outer perimeter of the bodywork. Installation according to FIA J art 253 – 14.2.
- 8.20.16. Filler neck (except for filler connectors), fuel tank, fuel catch tank, filter(-s), pump (-s) must be outside the cockpit (points 2.2. and 7.6.2. of these regulations).
- 8.20.17. Liquefied or natural gas tanks (cylinders) - prohibited.
- 8.20.18. Fuel – grade E98 or lower. Any kind of additives - prohibited
- 8.21. Exhaust system.**
 - 8.21.1. All engine exhaust gases must enter the main exhaust pipe and exit it at the end of pipe.
 - 8.21.2. The end (exit) of the exhaust pipe must be situated within the perimeter of the car and less than 100 mm from this perimeter in the rear. No parts of the chassis should be used to evacuate exhaust gasses.
 - 8.21.3. Exhaust manifold – original, between the cylinder head flange and the inlet point of catalytic converters. It means, that catalytic converters may be removed (including their steel cartridges) and interchanged with two tubes (max external diameter of one tube 2.5").
 - 8.21.4. Downstream from the manifold exhaust system is FREE. Additional mufflers – authorized.
 - 8.21.5. Lambda sensors – FREE.
 - 8.21.6. Maximum noise level: 105 dB (A) at 6000 RPM. This measurement will be taken at a distance of 0,5 m and at a 45 degree angle to the point of exit of the exhaust.
- 8.22. Ignition system - original. Spark plugs are FREE.**
- 8.23. Engine ventilation system – FREE.** In case of an open type sump breather, the system must be equipped in such a way, that the oil flows into the catch tank, with a minimum capacity of 1,0 liter. It is recommended to follow the requirements of FIA J art 255 – 5.1.14.
- 8.24. Engine management.**
 - 8.24.1. Engine control unit (ECU) – original in original location (box). **Software – original (with exceptions in official bulletin TBA).**
 - 8.24.2. REV limiter value – **6800 RPM (tolerance of +100 RPM will be accepted).**
 - 8.24.3. Engine wiring harness – original.

- 8.24.4. Data logger for scrutineering are mandatory. Data logger will be used for wheel power calculation to check engine power level against expected stock car engine power with set margin. All cars for scrutineering purposes must have AIM Solo 2 DL data logger with the CAN/RS232 + external power cable. Loggers with extended informational support can be bought from SO Engineering. Contacts: info@soe.fi, +358 (0) 44 29 222 15. Discount code for Solo 2 DL logger: **batcc14**. Data logger must be fully operational during the whole race weekend (free practices, qualifying and races). Data logger must be placed on open place below the windscreen for good satellite reception not under the dashboard sun lip. It's participant's responsibility to ensure that the data can be downloaded at all times during the race weekend. Data logger must be connected to 12V supply and to CAN bus of the car (not to the OBD2 port). Data loggers are strictly for Scrutineering purposes only. The configuration of the data logger is password protected and is only allowed to be changed by the scrutineer. Data loggers must be named by the respective number of the car.
- 8.24.5. OBD connector – original (in working order).
- 8.24.6. Engine start button (including IMMO module) – FREE.
- 8.24.7. Additional dash and sensors are allowed if they do not enhance engine performance.
- 8.25.** AC (climat control) pump, radiator (including dryer) tubes and hoses up to firewall – may be removed. For a purpose of that, it is allowed to use shorter belt and non-original belt tensioner.
- 8.26.** Sealing of the engine. Two fasteners of the oil pan and cylinder head cover must be pierced (2,0 mm) for a purpose of engine sealing.
- 8.27.** Other engine parts and systems - FREE.

9. TRANSMISSION

- 9.1.** Transmission type - two-wheel (rear) drive.
- 9.2.** Clutch - original.
- 9.3.** Clutch drive (pedal, master and slave cylinders) - original.
- 9.4.** Clutch fluid lines may be replaced by aviation type tubes or hoses. It is permitted to run these lines inside the cockpit according to paragraph 16 of these regulations.
- 9.5.** Gear box – original (6 speed manual).
- 9.6.** Gear box mounting (brackets and bushings) – FREE, but original position of the gear box must be retained.
- 9.7.** Gear ratios - original.
- 9.8.** Reverse gear - mandatory.
- 9.9.** Gear change system – FREE, but gear change H pattern must be retained.
- 9.10.** Propshafts (including CV joints) - original.
- 9.11.** Driveshafts (including CV joints) - original.
- 9.12.** Rear differential – original, but may be modified for an installation of LSD. Bushings of the rear differential – FREE.
- 9.13.** Main gear ratio – 3,73 only.
- 9.14.** Limited slip differential systems - FREE.
- 9.15.** Transmission cooling system – FREE.
- 9.16.** Other transmission parts - FREE.

10. BRAKING SYSTEM

- 10.1. Double circuit brake system, operated with one pedal - compulsory. The pedal must normally control all wheels, but in the event of any type of brake failure, the pedal must brake at least two wheels.
- 10.2. Brake pedal and drive – original (additional pedal pad authorized).
- 10.3. Brake light switch - compulsory with retained function.
- 10.4. Master cylinder (including fluid tank) - original.
- 10.5. Brake booster – original, but vacuum hose may be disconnected.
- 10.6. Anti-lock braking system – original in original location. May be electrically disconnected via main electrical connector on the ABS block or via fuse. ABS sensors must be retained and connected to the wiring circuit.
- 10.7. Brake calipers (front and rear) – original (**dust caps may be removed**).
- 10.8. Brake discs (front and rear) – FREEMAX with external diameter – 300 mm (according to official bulletin). No drilling or grooving allowed. **Front disc: BD3405, rear disc: BD3406 and BD1974.**
- 10.9. Brake pads – **one manufacturer FRITECH.**
- 10.10. Hand brake – original (in working order).
- 10.11. Brake balance adjuster - forbidden.
- 10.12. Brake lines may be replaced by aviation type tubes or hoses. It is permitted to run these lines inside the cockpit according to paragraph 16 of these regulations.
- 10.13. Brake cooling by air – FREE. For a purpose of that, it is allowed to use fog light apertures in the front bumper. Original size of the apertures must be retained.
- 10.14. Other parts of the braking system - FREE.

11. STEERING

- 11.1. Front wheel steering principle must be retained.
- 11.2. Steering wheel - FREE.
- 11.3. Steering wheel quick release system - recommended.
- 11.4. Steering drive (shafts and their hinges) - original.
- 11.5. Steering wheel lock - must be an inoperative or removed.
- 11.6. Steering wheel position adjuster – original.
- 11.7. Steering rack – original from any BMW E90 or E92 (318, 320d, 335, etc).
- 11.8. Steering rods (including rod ends) - original.
- 11.9. Power steering (pump, motor, gear and fluid tank) - original. Fluid lines are FREE.
- 11.10. Power steering cooling system – FREE.
- 11.11. Other parts of the steering system - FREE.

12. SUSPENSION

- 12.1. The operating principle of the suspensions - original.
- 12.2. Wheel base - original.
- 12.3. Springs – ST XTA (according to official bulletin).
- 12.4. Spring supports - ST XTA (according to official bulletin). Rear axle spring supports may be removed.
- 12.5. Shock absorbers - ST XTA (according to official bulletin).
- 12.6. Shock absorber top mounts (bearings) - ST XTA (according to official bulletin). May be adjustable in transverse direction only (camber adjustment). No caster adjustment allowed.
- 12.7. Uprights (including bearings, hubs) - original.
- 12.8. Wishbones, trailing arms – original (including bushings). BMW M3 parts are prohibited.
- 12.9. Anti-roll bars (sway bars) and their connections with the suspension (rods, bushings) – original. Size of the front bar (measures to be done at marked places) – 23,5 mm, size of the rear bar – 14,0 mm.

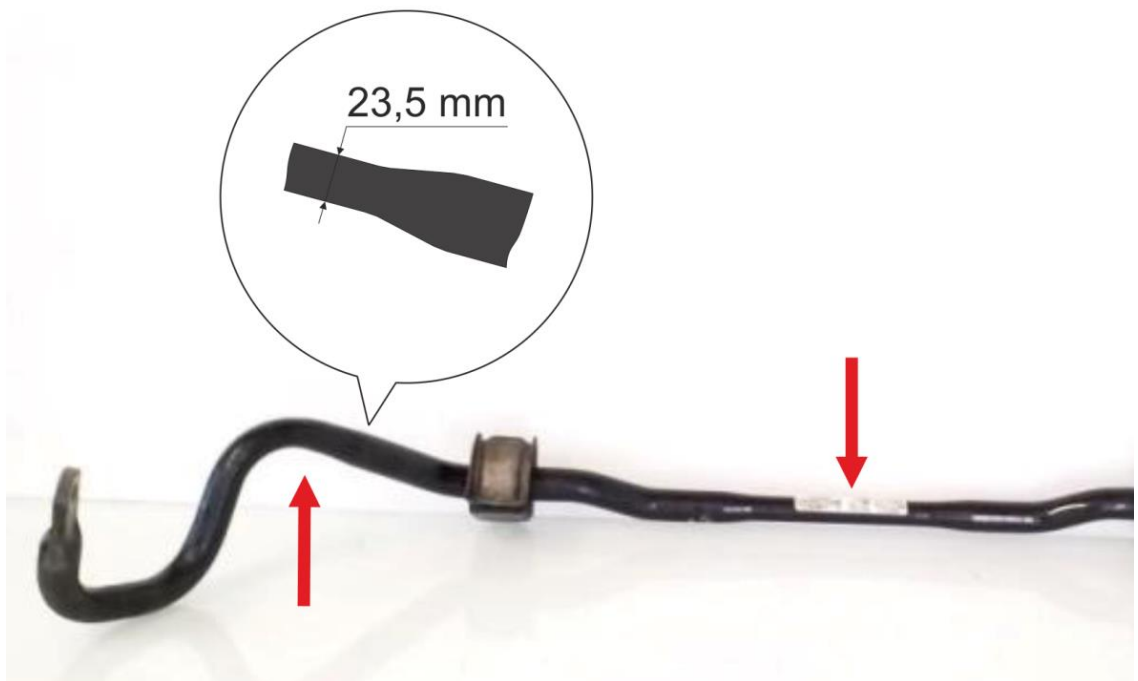

- 12.10. Suspension joints (bushings, bearings) – original (including bottom bushings of the rear shock absorbers).
- 12.11. Subframes – original (including bushings, which may be from BMW M3 model), **but may be reinforced according to homologation form.**
- 12.12. Suspension mounting points – original, but may be strengthened by adding material of the same shape. Connections with the roll cage authorized.
- 12.13. *Sensors* – no sensors allowed (except original ABS sensors).
- 12.14. Other parts of the suspension - FREE, but they can not be made of composite materials.
- 12.15. Ground clearance. No part of the car must touch the ground when tyres on one side are deflated. This test must be carried out on a flat surface under race conditions with driver onboard
- 12.16. **Camber (front and rear) – max 3° (tolerance of +0,1° will be accepted).**

13. WHEELS

- 13.1.** Fenders (bodywork) must completely cover the wheels (incl. wheel studs) from the top. With the wheels straight (with no damages to suspension) the projection line „A“, lined with the side of the wheel, must cut through or touch the fender at the point „B“.

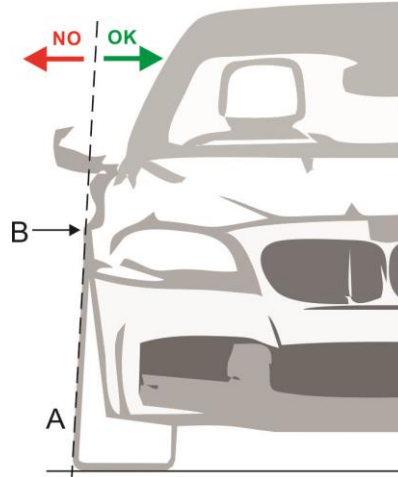

- 13.2.** Wheel fasteners. Serial fastening with bolts can be replaced by fastening with studs and nuts or axel fastening with one nut.
- 13.3.** Rims. Rims made of a magnesium are not permitted. The spacers between rim and wheel hub - authorised:
- Max size: width – 8“, diameter – R17, Min weight – 7kg.
- 13.4.** The use of NANKANG AR-1 tyres - compulsory:
- 13.5.** Max size – 225/45R17;
- 13.6.** Max quantity of the new tyres – 4 pcs × race weekend (race 1, race 2), **including two additional tyres for each semifinal**. Plus two new emergency tyres for all championship. Emergency understood as a damage of the tyre, caused accidentally during the race (cuts, bursts, etc). Marked tyres from the previous championship events may be used.
- 13.7.** Any heating (with a help of electrical or fuel power) or chemical treatment of the tyres is prohibited.
- 13.8.** Modifications of the tyre pattern – forbidden (including wet races)
- 13.9.** *Sensors* – no sensors allowed (tyre temperature, tyre pressure, etc).

14. LIGHTING AND ELECTRICAL EQUIPMENT

- 14.1.** External lighting must be original (including facelift lights). Front fog lights may be removed. Lights in working order:
- One pair of front (low beam) lights (55W);
 - One pair of red rear lights (10W);
 - One pair of red brake lights (21W);
 - One red rear rain (fog) light (21W) or may be equivalent LED light;
 - Two pairs of indicator lights – one pair in the front, one - in the rear (21W);
 - Max two pairs of the front additional lights may be used;
 - Recognition lights may be installed (max 5W or equivalent LED).
- 14.2.** Alternator - original.
- 14.3.** Starter - original.
- 14.4.** Battery - FREE. If battery is moved from its original location, it must be installed according to FIA J art 255 - 5.8.3. Battery in the cockpit may be dry type battery (cover on the „+“ pole – compulsory). Fluid tight container for a wet type battery must be used. Battery must be installed behind the line of the driver seat.
- 14.5.** Wiring harness – original, but may be modified by removing not usable wires (airbag system, audio system, front seat, etc). Must be installed according to paragraph 16.
- 14.6.** Other lighting and electrical equipment - FREE.

15. GENERAL CIRCUIT BREAKER

- 15.1.** The general circuit breaker – compulsory. It must cut out all electrical circuits from the battery and switch of the engine. Installation and use according to FIA J art 253 - 13.

16. LINES (HOSES, PIPES) AND ELECTRICAL CIRCUITS

- 16.1.** Obligatory application if the series fitting is not retained.
- 16.2.** Oil, fuel, and hydraulic lines must be protected externally against any risk of deterioration (stones, corrosion, mechanical breakage, etc) and internally against any risk of fire and deterioration.
- 16.3.** Any lines containing cooling water (fluid) or lubricating oil must be outside the cockpit.
- 16.4.** Lines containing fuel or hydraulic fluid may pass through the cockpit, but without any connectors inside the cockpit, except on the front and rear bulkheads and on the braking and clutch circuits.
- 16.5.** In case of flexible lines, threaded, crimped, or self-sealing connectors and an outer braid resistant to abrasion and fire must be used.
- 16.6.** In places where lines or wires pass through firewalls, the edges of the holes must be covered with protective materials.
- 16.7.** No lines or wiring, no cables or lines of the fire extinguishing system may pass between the bodywork and outer perimeter of the roll cage.
- 16.8.** Additional information FIA J art 253 - 3.

17. SAFETY CAGE

- 17.1.** The fitting of the safety cages is compulsory. It may be either:
- Homologated (certified) by FIA or ASN. The homologation form or safety cage certificate must be present at every race event;
 - Fabricated in compliance with the requirements of the FIA J art 253.8 (2020). The national safety cage certificate (or other) must be present at every race event.
- 17.2.** Minimum safety cage structure (for cages built after 31.12.2020):

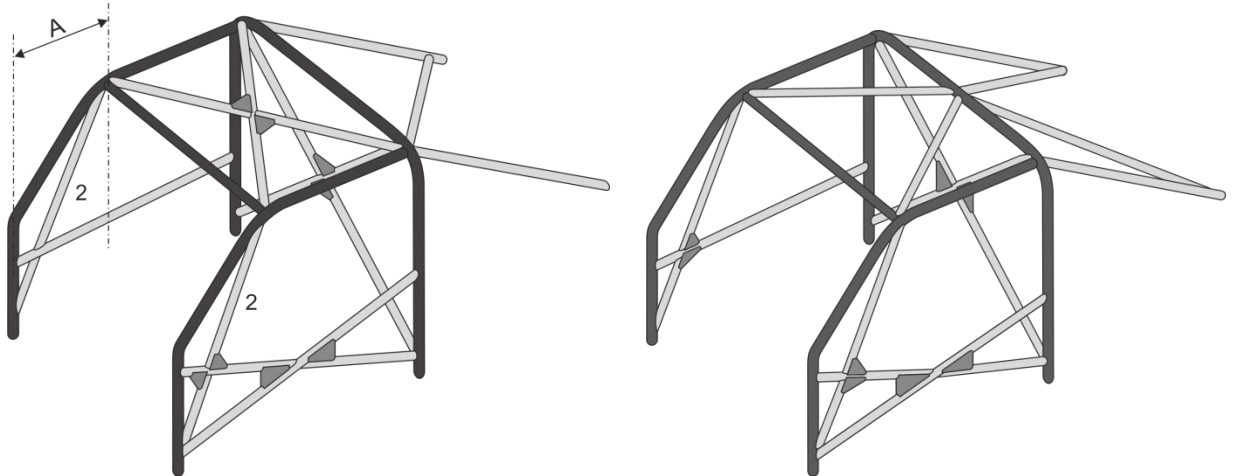

- 17.3.** Places (marked red in picture) , where the driver's helmet can come into contact with the safety cage during an accident, must be covered with a padding in accordance with FIA 8857-2001 standard. Padding must be fixed tightly to the safety cage bar, with no possibility to move it or to turn it on the radius of the bar.

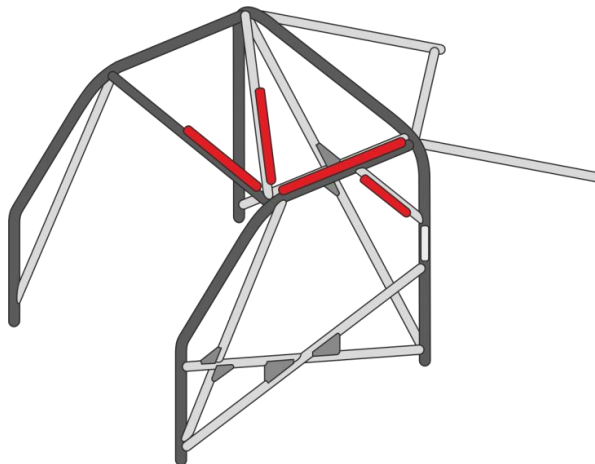

18. SAFETY HARNESS, SEATS, WINDOW NET AND DRIVERS EQUIPMENT

- 18.1. Safety harness. Six point, mechanically or (and) chemically undamaged safety harnesses in compliance with FIA 8853/98, 8853-2016 standards must be used. Installation and use according to FIA J art 253 - 6.2 / 6.3. No homologation extensions allowed. Elastic devices attached to shoulder straps are prohibited.
- 18.2. Belt cutter - compulsory. It must be easily accessible for the driver when seated with his harnesses fastened.
- 18.3. Seat. Mechanically or (and) chemically undamaged seat in compliance with FIA 8855-1999, 8862-2009 standards must be used. Installation and use according to FIA J art 253 - 16. Homologation extension of 5 years, without approval of the manufacturer, allowed.
- 18.4. Window net – mandatory. Installation and use according to FIA J art 253 – 11. The use of hand straps instead of a net is authorized. The installation and use of this equipment must ensure the protection of driver's hands.
- 18.5. Drivers equipment. Clothing (overalls, shirt, trousers, socks, balaclava, shoes, gloves) in compliance with FIA 8856-2000 or 8856-2018 standard must be used.
- 18.6. Helmet. Helmet in compliance with (FIA (SNELL) SA2005 / SA2010 / SAH2010 + 8858-2002, SA2005 / SA2010 / SAH2010 + 8858-2010, 8858-2002, 8858-2010, 8860-2004, 8860-2010, 8859-2015, 8860-2018) standards must be used. Any additional equipment (cameras, camera-holders) that are not provided by the manufacturer - prohibited.
NOTICE: *helmets in compliance with FIA (SNELL) SA2005 + 8858-2002, SA2005 + 8858-2010, 8860-2004 are prohibited in the FIA events (expired homologation).*
- 18.7. Head restraint systems (HANS, HYBRID). Head restraint systems in compliance with FIA 8858-2002, 8858-2010 standards must be used.

19. FIRE EXTINGUISHING EQUIPMENT

- 19.1. Fire extinguishing systems - recommended. Installation according to FIA J 253 - 7.2.
- 19.2. Manual fire extinguisher – mandatory (min 2 kg), if no fire extinguishing system installed in the car. Manual fire extinguisher must be easily accessible for the driver. Installation according to FIA J art 253 - 7.3.

Done by: Egidijus Janavicius (+370 685 01303)